

City of Santa Barbara

Access & Parking Design Standards

1. Introduction & Purpose
2. Application
3. General Requirements
4. Pedestrian Circulation & Access
5. Surface Parking & Structures
6. Tandem Parking
7. Parking Lifts & Machines
8. Valet Operations
9. Motorcycle Parking
10. Individual Garages
11. Carports
12. Driveways & Vehicle Ramps
13. Bicycle Parking

1. Introduction & Purpose

The purpose of the City of Santa Barbara Access & Parking Design Standards is to provide for quality, well-functioning site access and vehicle storage. These standards address parking design, on-site circulation, and the interface of property with the City's circulation network.

These standards are designed to further the access and parking-related goals, policies, and direction of the City's General Plan, Zoning Ordinance, Pedestrian Master Plan, Bicycle Master Plan, Urban Design Guidelines and Vision Zero.

A basic objective of standards is to further the General Plan's goal to provide equality of convenience and choice among modes of transportation by promoting safe and attractive facilities for walking, bicycling, and driving. The General Plan also includes policy direction to optimize parking resources and facilitate active modes of transportation.

While these standards focus on function, access and parking require extensive land area and have considerable impacts on the environment that are addressed in other City guidance

documents. Designers are encouraged to consult the following City documents, which also provide direction related to site access and design:

- General Plan Circulation Element
- Coastal Land Use Plan
- Zoning Ordinance
- Pedestrian Master Plan
- Bicycle Master Plan
- Urban Design Guidelines
- Architectural Board of Review Guidelines
- El Pueblo Viejo District Guidelines
- SFDB General Design Guidelines
- Single Family Residence Design Guidelines
- Outdoor Lighting and Streetlight Design Standards
- Storm Water Management Program and BMP Guidance Manual
- Fire Department Requirements
- Public Works Construction Standard Details

2. Application

These standards apply to projects in which changes are proposed to the parking areas and require design review and/or a building permit. The Zoning Ordinance provides for waivers and reductions of these standards where warranted.

3. General Requirements

The number of required bicycle and automobile parking spaces for a proposed development is established in the Zoning Ordinance Parking Regulations. The minimum parking requirement is intended to provide off street vehicle storage to internalize some parking demand generated by development. The Parking Regulations provide for flexibility with reductions in existing on site automobile parking supply to provide for accessibility, improve circulation safety, provide for bicycle and motorcycle parking, provide space for trash enclosures, and improve aesthetics. For assistance in determining the number of parking spaces required for a project and options to substitute existing automobile parking for other site improvements, please visit the Planning & Zoning Counter at 630 Garden Street, or call (805)564-5578.

The California Building Code requires accessibility improvements and electric vehicle charging, depending on the project scope. Accessibility improvements can include the number, size and location of accessible parking spaces, access aisles, and paths of travel to building entrances and trash enclosures. For more information about the requirements, please visit the Building & Safety Counter, or call (805)564-5485.

To ensure all of the standard information is provided on your plans, please refer to the Design Review Submittal Checklist. Note that field inspections will be made prior to final occupancy to verify constructed access and parking facilities comply with all City standards.

The minimum stall width and bay width dimensions are based upon a composite vehicle as established by the American Association of State Highway and Transportation Officials (AASHTO) and the American Institute of Architects (AIA).

The City Standard Design Vehicle in the following figure is used to verify maneuvering for parking configurations that do not conform to the parking layouts in the figures below.

FIGURE I: STANDARD DESIGN VEHICLE

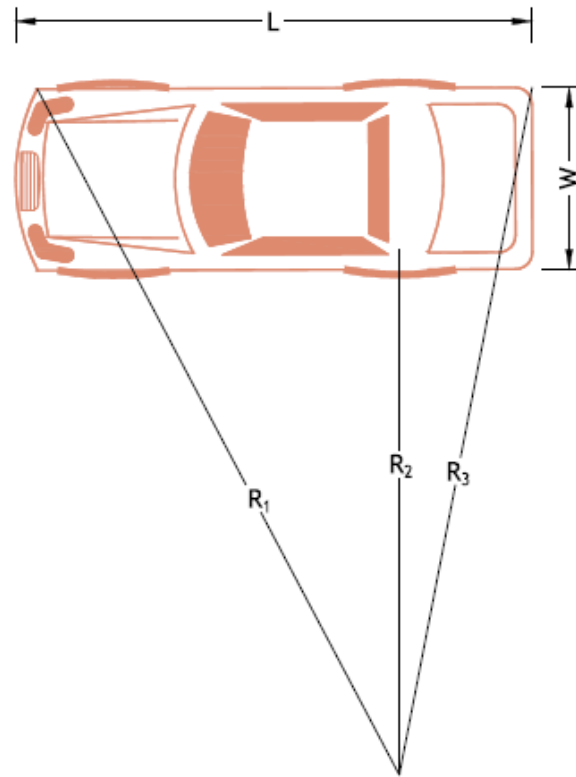

Symbol	Description	Measure
L	Length	16'-6"
W	Width	5'-10"
R ₁	Turning Radius: Outside front bumper	21'-3"
R ₂	Min. Turning Radius: Inside rear wheel	11'-8"
R ₃	Min. Turning Radius: Outside rear bumper	18'-3"

4. Pedestrian Circulation & Access

On site pedestrian circulation should be designed to be safe and provide reasonably direct, convenient connections between primary building entrances and the adjacent pedestrian network. For all development (except Single Unit Residential), plans shall illustrate pedestrian paths and demonstrate pedestrian circulation and access based on the following, where feasible. Exceptions to these standards may be approved by the design review authority. Consult Building & Safety staff to determine what ADA accommodations are required.

- A. **Paths to Adjacent Sidewalks and Transit.** Pedestrian paths shall be provided and designed to minimize walking distance from the primary entrances of all buildings to adjacent pedestrian facilities and transit stops.
- B. **Paths for Properties not Fronting Sidewalk.** For buildings and uses on properties not fronting a public sidewalk, a pedestrian path shall be provided along the main entrance facades of all buildings consistent with through-block pedestrian pathway standards provided in the Pedestrian Master Plan.
- C. **Paths between Uses.** Pedestrian paths shall be provided between the primary entrances to businesses, uses, and/or buildings on the subject property.
- D. **Paths Connecting Properties.** Where appropriate, pedestrian paths should be provided connecting adjacent properties and access points coordinated between properties to provide convenient pedestrian links between properties.
- E. **Security.** Pedestrian paths should provide a sense of security by the addition of lighting consistent with Outdoor Lighting Guidelines.

5. Surface Parking & Structures

Parking structures and surface parking standards are intended to provide safe, efficient circulation within a parking area and convenient ingress and egress.

- A. **Minimum Stall Dimensions.**
 - 1. The minimum standard stall width for all uses is 8.5'. Wider stalls may be required when parking bay widths are narrower than standard or vertical elements are adjacent to stalls.
 - 2. In parking lots containing more than ten spaces, a maximum of 30% of all required automobile parking may be for compact cars. The minimum compact stall width is 8'. The compact spaces shall be distributed throughout the parking lot, rather than concentrated in one area to maximize access and usability.
- B. **Minimum Bay Dimensions.** Figures 2 & 3 provide minimum dimensions for 90 degree and angled parking for single loaded bays and double loaded bays. Parking stall angles less than 45 degrees are not permitted. Parking stall angles greater than 75 degrees and less than 90 degrees are also not permitted to minimize instances of

automobiles exiting the wrong way. Parking lots with angled parking configuration shall be designed for one-way circulation.

FIGURE 2: 90 DEGREE PARKING

Parking Lot Dimensions						
Stall Length	Stall Width	Aisle	Module		Overhang Allowance	P
(A)	(B)	(D)	(E1)	(E2)	(G)	(P)
17'-6"	8'-6"	23'	40'-6"	58'	2'-6"	-
17'-6"	9'	21'-6"	39'	56'-6"	2'-6"	-
17'-6"	9'-6"	20'	37'-6"	55'	2'-6"	3'-6"
17'-6"	10'	18'-6"	36'	53'-6"	2'-6"	4'
17'-6"	10'-6"	17'	34'-6"	52'	2'-6"	4'-6"
17'-6"	11'	15'-6"	33'	50'-6"	2'-6"	5'

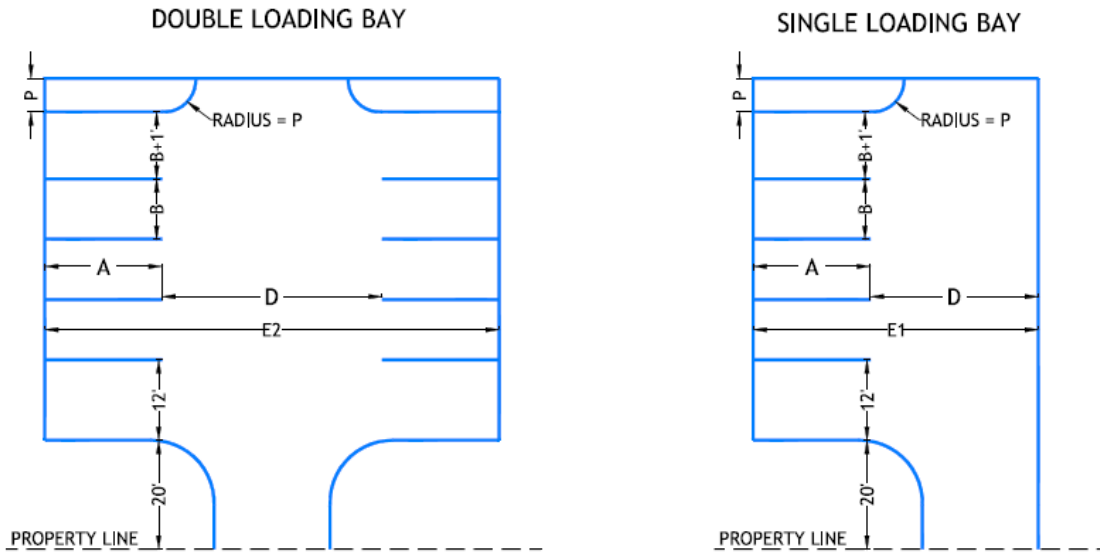

OVERHANG ALLOWANCE (G)

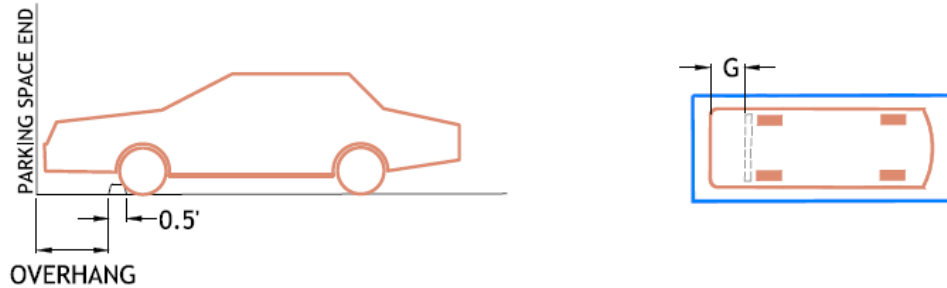
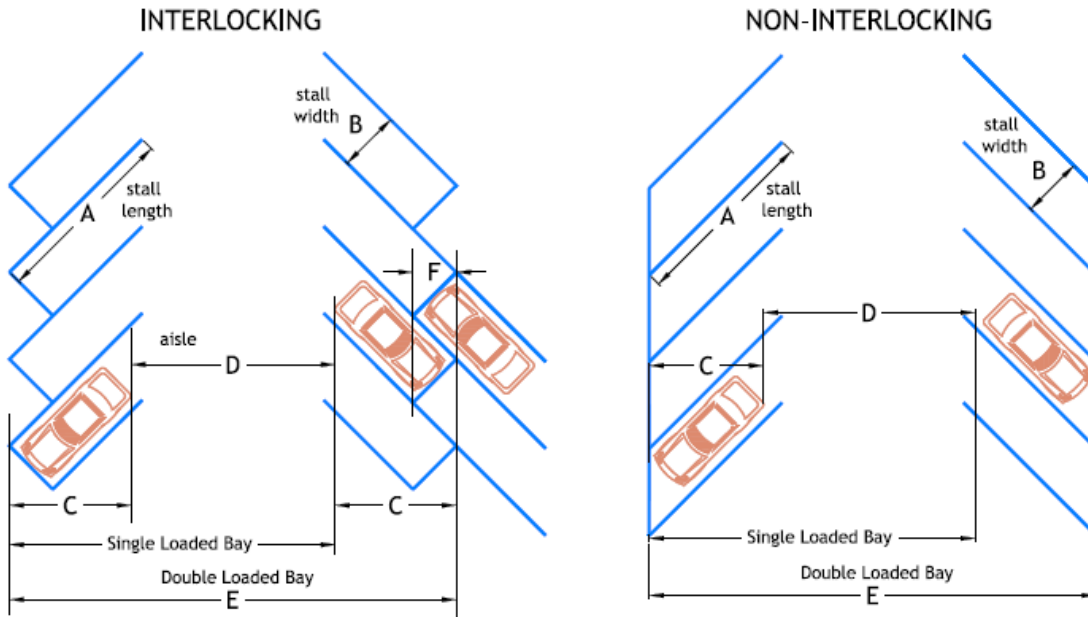

FIGURE 3: ANGLED PARKING

Parking Lot Dimensions - Universal Sized Stall (8.5 feet x 17.5 feet)							
Parking Angle	Stall Length	Stall Width	Projection	Aisle	Module	Interlock Reduction	Overhang Allowance
	(A)	(B)	(C)	(D)	(E)	(F)	(G)
45°	17'-6"	8'-6"	17'	13'	47'	2'	2'
50°	17'-6"	8'-6"	17'-6"	13'	48'	2'	2'
55°	17'-6"	8'-6"	17'-6"	14'	49'	2'	2'
60°	17'-6"	8'-6"	18'	15'	51'	1'-6"	2'
65°	17'-6"	8'-6"	18'	16'	52'	2'	2'
70°	17'-6"	8'-6"	18'	17'	53'	2'	2'
75°	17'-6"	8'-6"	18'-6"	18'	55'	1'	2'-6"

See ADA regulations for accessible spaces.

If the stall width is increased from the universal stall width of 8.5', then reduce the module (E) by 3 inches for each additional inch in stall width (B) while maintaining minimum aisle width.



OVERHANG ALLOWANCE (G)

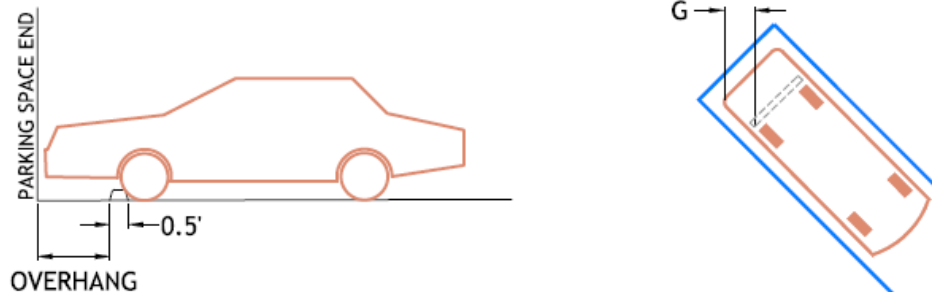

- C. **Vertical Elements.** If there is a vertical element in excess of 6” in height adjacent to a parking stall, an additional 1' of stall width is required to provide clearance.
- D. **On Site Loading.** An on site loading space shall be required if loading interferes with short-term or visitor parking. Dimensions of on site loading spaces will be required based on anticipated vehicles servicing the site.
- E. **Maneuvering.** The Zoning Ordinance requires turnaround movements to be accomplished in one maneuver. One maneuver is one back up and one forward movement.
- F. **Vehicle Overhangs.** Wheel stops or curbs should be placed to stop a parked vehicle, protect pedestrian access and adjacent property from parked vehicles, and encourage parking outside of the drive aisle. As shown in Figures 2 and 3, a portion of vehicle length can overhang a wheel stop or curb.
 - 1. An overhang is included as part of the total bay width where it is demonstrated that the Standard Design Vehicle can overhang. For an overhang to be considered as part of the total bay width, the curb pavement and landscaping at maturity must be 6” or less in height, where the overhang occurs in a planter.
 - 2. If a wheel stop is installed in a parking space, the distance from the front end of the space to the nearest point of contact with the wheel stop shall be 3’.
 - 3. Overhangs are prohibited in areas where a parking stall is adjacent to a pedestrian walkway that would be reduced to less than 4’ wide by the overhanging vehicle.

6. Tandem Parking

Tandem parking for both residential and nonresidential uses may be approved by the Public Works Director, provided it conforms to the requirements in the Zoning Ordinance Parking Regulations for tandem parking.

7. Parking Lifts & Machines

The Circulation Element encourages innovative parking design, including parking lifts. Parking lifts and parking machines will be reviewed on an individual basis with relevant parking lot/garage dimensions and the standard design vehicle to ensure adequate maneuverability is provided.

- A. **Uses.** Parking lifts and parking machines are appropriate for residential uses and nonresidential uses where the duration of vehicle storage is typically for long periods of time, such as hotel with valet. When parking machines are proposed, staff will review the project to ensure it is appropriate for the proposed land use as outlined by the Zoning Ordinance.
- B. **Stall Height.** Parking lifts must maintain stall heights as follows:
 - 1. Minimum 6.5’ clear height for spaces on the ground floor, or from where the vehicles are accessed

2. Minimum 5' clear height for remaining levels in which users do not have direct access to the vehicle
- C. **Vehicle Accommodation.** Parking machines must demonstrate the ability to accommodate a range of vehicle sizes to ensure viability. Nonresidential projects utilizing a parking machine, shall provide a minimum of 25% of the required parking as surface parking. Compact spaces will not be permitted in parking areas provided to meet this requirement.
- D. **Compact Spaces.** A maximum of 30% of the parking spaces within a parking machine or parking lift facility may be designated for compact vehicles.
- E. **Valet.** A valet may be required for parking lifts or parking machines serving nonresidential uses in which the parking facility serves infrequent users, or where the duration of visit is anticipated to be for a short period of time.
- F. **Maneuvering.** Maneuvering area shall be provided for parking lifts and machines consistent with garage standards, as appropriate to account for vertical elements of the machines.
- G. **Loading.** A loading area for convenient transfer of goods and passengers shall be provided for facilities with parking lifts or parking machines serving ten or more automobiles.
- H. **Accessible Parking.** Consult with Building and Safety staff to determine requirements for providing ADA accessible parking facilities where a parking machine is proposed.

8. Valet Operations

- A. **Use of Public Facilities.** Valet parking, vehicle storage, pickup, drop-off, or vehicle movements shall not use any street, alley, or City-owned parking facilities, or interfere with any right-of-way without approval of the Public Works Director. Valet parking shall not remove or interfere with automobile or bicycle parking required for any use.
- B. **Recorded Agreement.** Pursuant to Zoning Ordinance procedures for Recorded Agreements, sites requiring valet parking services must ensure a parking attendant will be on duty at all times that the facility is in use, and provide sufficient staff and facilities to ensure that automobiles are moved for parking promptly. If, at any time during the operations of the valet facility is unable to satisfy the parking demand, and queueing or double-parking occurs, the operation shall be temporarily closed until the demand can be properly handled.
- C. **Accessible Parking Facilities.** Valet operators are required to keep all accessible parking spaces and associated access aisles unobstructed and available for parking for individuals with disabilities at all times.

9. Motorcycle Parking

Motorcycle parking is encouraged where there is extra space in parking lots. The Municipal Code allows for the conversion of existing automobile parking spaces to motorcycle parking

in some cases. When automobile parking is converted to motorcycle parking, motorcycle parking shall meet the following standards.

- A. **Location.** Motorcycle parking shall be located near a main entrance to encourage use and enhance visibility to minimize theft and vandalism.
- B. **Dimensions.** Each motorcycle parking space must have a minimum delineated area of 4' x 8'.
- C. **Signage.** Parking lots that include motorcycle parking spaces shall have signage indicating motorcycle parking.

10. Individual Garages

Garages must be available for the parking and storage of vehicles at all times. Newly constructed garages shall be designed to meet the following standards and maneuvering area illustrated in Figures 4 & 5.

- A. **Dimensions.**
 - 1. One car garage minimum interior clear area 10' x 20'
 - 2. Two car garage minimum interior clear area 20' x 20'
 - 3. Garage minimum interior height 6.5'
- B. **Garage Doors.** The minimum garage door widths are 8' for a one car garage and 16' for a two car garage. Garage doors will be reviewed to ensure that adequate maneuvering is provided.
- C. **Storage and Utilities.** Storage and utilities may be located within the interior clear area of a garage or carport, provided that storage and utilities are located a minimum of 4' above the garage or carport floor and do not extend beyond 4' from the back wall of the garage or carport.

11. Carports

The Zoning Ordinance defines a carport as a structure, or portion of a structure, accessible to vehicles, with a solid weatherproof roof that is permanently open on at least two sides, and used as parking for one or more motor vehicles. Newly constructed carports shall be designed to meet the following standards and maneuvering area illustrated in Figures 6 & 7.

- A. **Dimensions.**
 - 1. One stall carport minimum interior clear area 8' x 20'
 - 2. Two stall carport minimum interior clear area 16' x 20'
 - 3. Carport minimum interior height 6.5'
- B. **Vertical elements.** Vertical elements within 1' of the minimum clear width may be no more than 6" high.

FIGURE 4: ONE CAR GARAGE

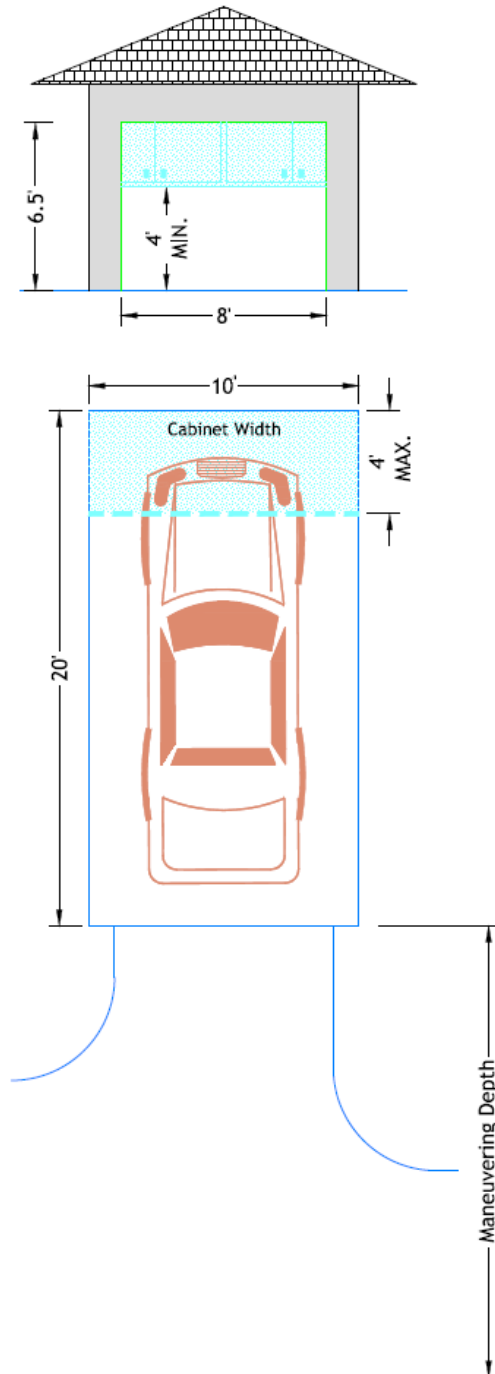

Minimum Garage Door Dimension 8'

Minimum Interior Unobstructed Dimensions 10'x20'

Required Maneuvering Depths, Maneuvering Depth (Md) Door Width (Dw)						
Dw	8'	9'	9.5'	10'	10.5'	11'
Md	28'	27'	26.5'	24'	23'	20'

FIGURE 5: TWO CAR GARAGE

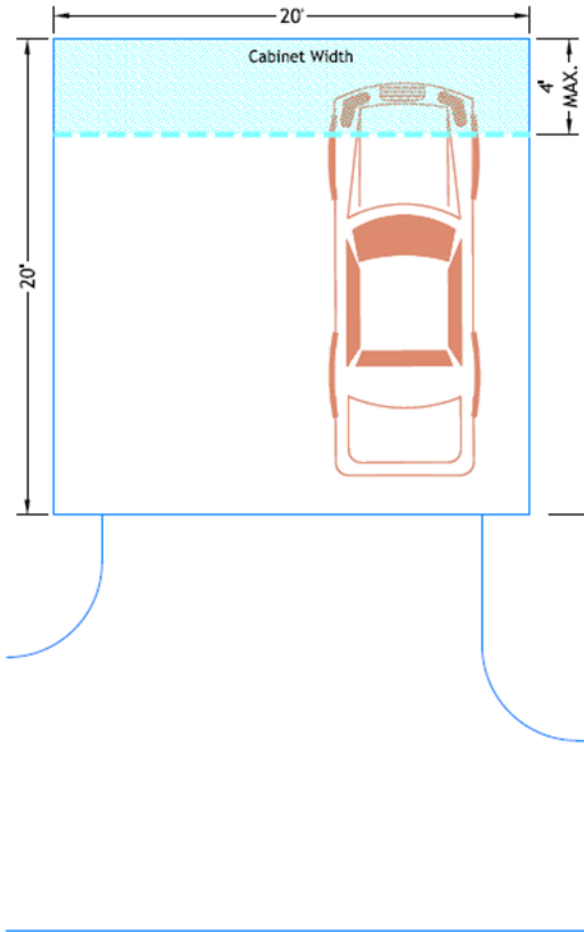
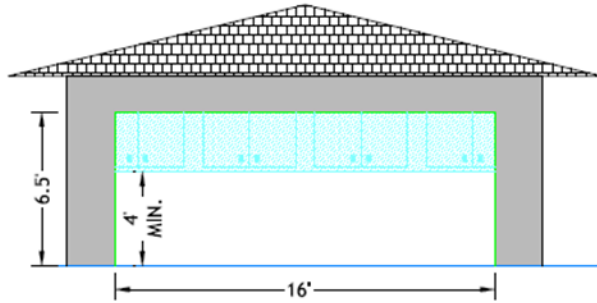

Minimum Garage Door Height 6.5'
 Minimum Garage Door Width 16'
 Note: Arch-framed garage doors may require additional width to accommodate 6.5' height requirement.

Minimum Interior
 Unobstructed Dimensions 20'x20'

Required Maneuvering Depths, Maneuvering Depth (Md) Door Width (Dw)						
Dw	16'	17'	18'	19'	20'	22'
Md	27'	26'	25'	24'	23'	20'

FIGURE 6: ONE STALL CARPORT

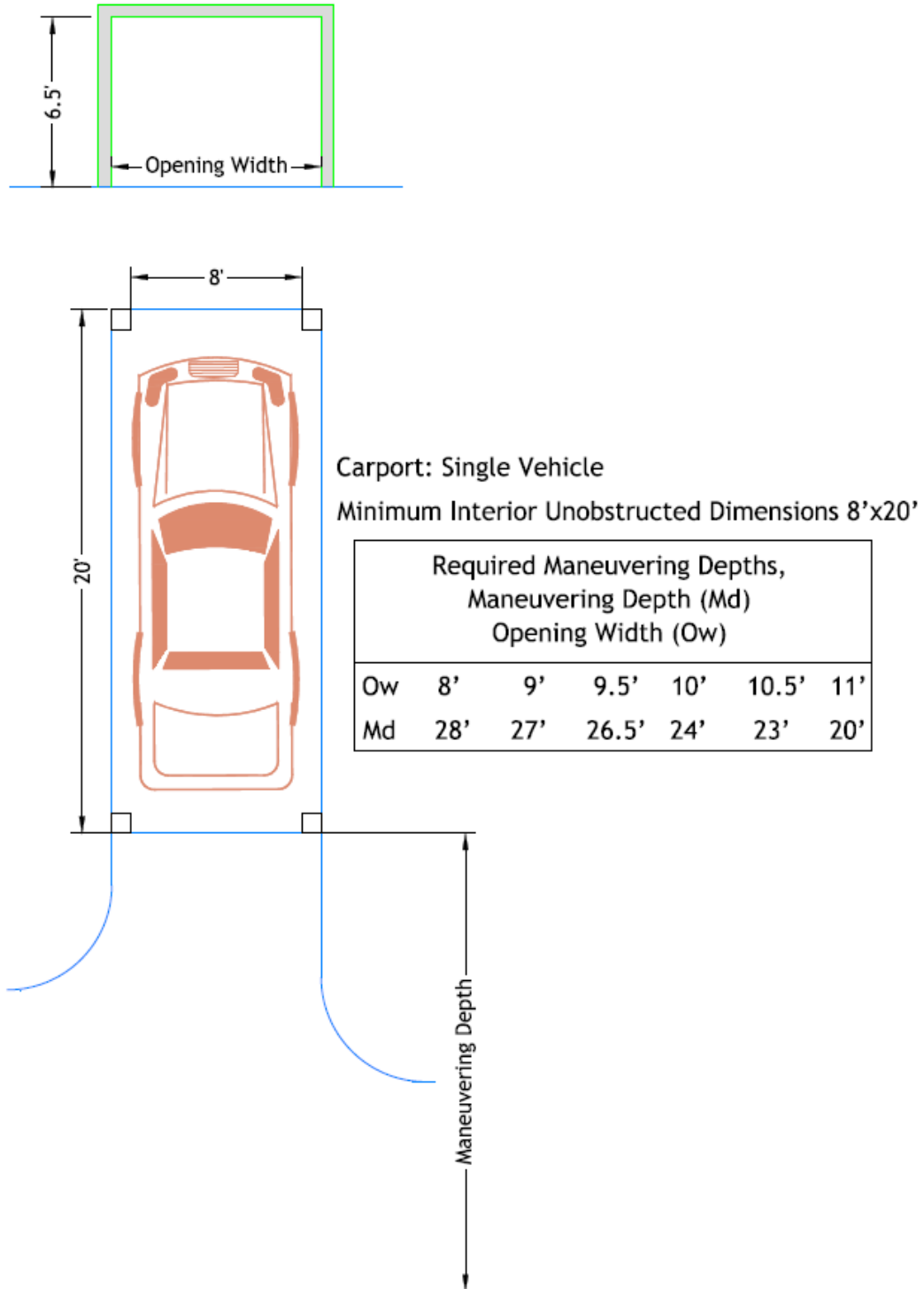
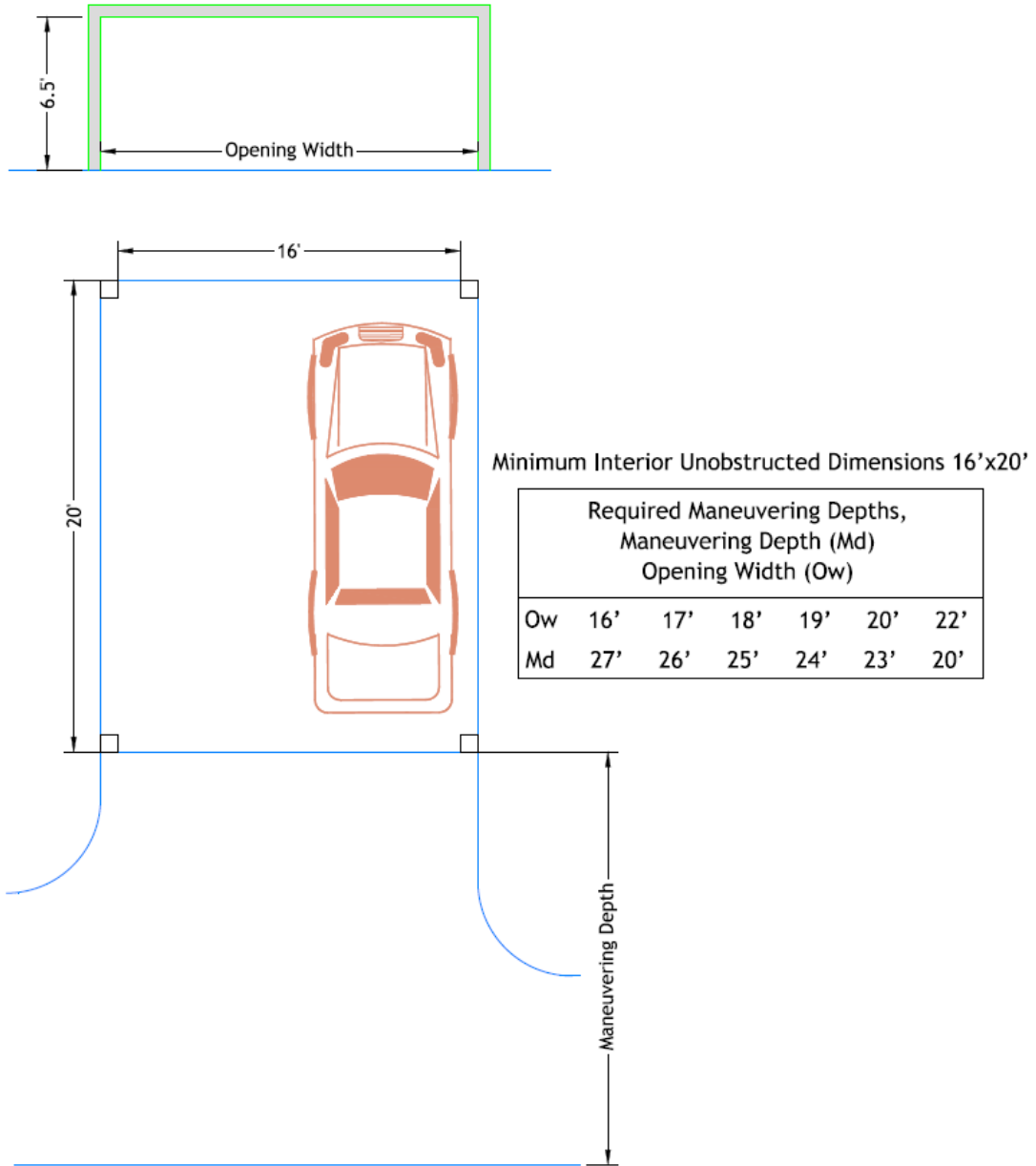

FIGURE 7: TWO STALL CARPORT



12. Driveways & Vehicle Ramps

Driveway access to automobile parking areas shall be consistent with the California Fire Code and the following:

A. Driveway Width.

1. Residential driveways serving residential uses shall be a minimum of 10' and a maximum of 16' in width on-site, unless determined that a wider driveway is necessary for access to required parking spaces, vehicular maneuvering or Fire access.
2. Where a parking area contains less than 25 parking spaces, one way driveway access shall be not less than 10' for residential and 12' for nonresidential.
3. Where a parking area contains 25 or more parking spaces, or a projected total of 25 or more parking spaces, a two-way driveway is required with a minimum paving surface width of 22'. Exceptions may be made to the minimum width of a two-way driveway for low volume streets. Two one-way driveways may be substituted for a two-way driveway.

B. Driveway Aprons. Residential driveway aprons may be between 10' and 16' wide. Commercial driveway aprons may be between 12' and 30' wide. Refer to the Public Works Standard Construction Details for standard driveway apron designs. Driveway aprons and driveways shall be as narrow as possible with consideration of maneuvering and circulation safety.

C. Driveway Length.

1. The minimum length of driveway for parking spaces that back to a public street is 20'.
2. Driveways exceeding 75' in length require a turnaround area on site.
3. When the distance from the street pavement to the rearmost wall of any structure on the subject parcel is less than 150', the maximum driveway grade shall be 20%. The 150' is measured along the driveway. When Fire Department access is required, the slope of the driveway shall not exceed 16%.

D. Vehicle Ramps. A vehicle ramp is a sloping connection between a street level and a parking level or between two parking levels.

1. For multiple unit dwellings or non-residential uses, all parking plans involving ramps shall be accompanied by a profile showing the ramp, ramp transitions and overhead and adjacent wall clearances.
2. The length of a ramp is defined as that portion of the ramp from the beginning of the transition at one end of the ramp to the end of the transition at the opposite end thereof.
3. For ramps longer than 65', the ramp grade shall not exceed 12% with the first and last 8' of the ramp not exceeding 6%.

4. For ramps 65' in length or less, the ramp grade shall not exceed 16% with the first and last 10' of the ramp not exceeding 8%.
 5. The slopes of all parking areas shall not exceed 5%, excluding ramps.
 6. When an ADA accessible route across a vehicle ramp is required the maximum slope is regulated by the California Building Code. Please consult Building & Safety staff for more information.
- E. **Vertical Curves.** Minimum vertical curve lengths provide for gradual transitions between a street/sidewalk and driveway and between a driveway and parking area.
1. If the slope of the driveway is 0 - 10%, a 5' minimum length vertical curve is required.
 2. If the slope of the driveway is 10 - 16%, a 10' minimum length vertical curve is required.
 3. When the slope of a driveway is rising to meet the sidewalk or garage level, 5' of the driveway shall be the same slope as the sidewalk or garage level.
- F. **Driveway Locations.** Driveways in a residential or low traffic volume areas shall not be located closer than 25' from an intersection. Circulation safety and right of way impacts will also be considered with a new driveway location or change of use. The locations of opposing driveways will also be considered for the potential for hazardous interlocking left-turn movements.
- G. **Gates.** All driveway gates, and arc of the gate swing shall be setback a minimum of 20' from the front lot line for any use to minimize sidewalk blockage and interference with traffic flow. A driveway gate for nonresidential uses may be located closer than 20' to a front lot line if the gate remains open during business hours and adequate visibility is provided. Remotely actuated gates located less than 20' from a front lot line will be evaluated on a case-by-case basis. Fire Department access may be required.
- H. **Visibility.** Please refer to the Zoning Ordinance for fence, wall, and hedge height restrictions for adequate visibility near driveways and property lines.
- I. **Driveway Materials.** All required off-street automobile parking areas and driveways within 100' of the property line shall be fully hard-surfaced with materials having equivalent service and durability as 2" thick asphaltic concrete, at minimum. Permeable paving solutions are encouraged.
- J. **Ribbon Driveways.** Ribbon driveways and permeable paving are encouraged in order to minimize impermeable surfaces. The "ribbon" portion of the driveway must be fully hard surfaced, while material between the ribbons shall not be loose material that can be carried into the public right-of-way by an exiting vehicle.
- K. **Driveway Throat.** Parking lots with 20 or more stalls are required to provide a 20' deep driveway throat. A 20' deep driveway throat may also be required for smaller lots where the vehicular traffic conditions so warrant (e.g. high volume or high speed streets). The driveway throat is measured from the front property line or edge of

public right of way to the first parking space. The throat is designed to prevent vehicles from obstructing traffic on the street or pedestrians on the sidewalk.

13. Bicycle Parking

Providing safe, well-designed, and high quality bicycle parking makes bicycling a more attractive and convenient option. Bicycle parking facilities are separated into two categories, short-term and long-term, based on the level of security desired in relation to parking duration.

Refer to the Zoning Ordinance for the minimum amount of short-term and long-term bicycle parking required for each use classification. The Zoning Ordinance also allows for some substitution of bicycle parking for automobile parking. Personal lockers, showers and changing areas in the workplace also support bicycle commuters and may be required with discretionary land use decisions.

The following table describes the general differences between long-term and short-term bicycle parking.

LONG-TERM AND SHORT-TERM BICYCLE PARKING		
	Long-term	Short-term
Fixtures	Lockers, Racks in Secured Area	Simple racks
Weather Protection	Sheltered	Unsheltered
Security	Individual lockers, Access-controlled bicycle room or enclosure	Passive surveillance (visible from street or by user)
Land uses	Residential, Workplace, Transit	Restaurant, Retail, Commercial, Recreation

Long-term bicycle parking consists of a variety of fixture types and site plan layouts and may include racks, rooms, and lockers located in a variety of settings, both indoors and outdoors. Because long-term parking areas often are located in low pedestrian use areas, site design focus is on ensuring the safety of users while maintaining exclusive access to these areas.

Short-term bicycle parking usually consists of simple bicycle racks located on site near the front of the building or destination. Site planning is focused on convenience, utility and to improve security for the basic bicycle rack. Design review approval for these exterior parking devices may be required. Samples of long-term and short-term bicycle parking are provided in Figures 8 & 9.

All bicycle parking facilities will be reviewed based on the following standards and design expectations.

- A. **Bicycle Parking Plans.** Bicycle parking plans shall include bicycle parking locations, long-term and short-term parking designations, parking rack/device type, bicycle parking layout with dimensions, enclosure details (where necessary), lighting (where necessary), and signage (where necessary).
- B. **Dimensions.**
 - 1. Each standard surface bicycle parking space shall be a minimum of 2' x 6'
 - 2. To increase visibility to pedestrians, short-term bicycle racks should have a minimum height of 32" or be identified by visible markers.
- C. **Location & Visibility.** Bicycle parking shall be at least as convenient as automobile parking. Short-term bicycle parking should be visible and as close as possible to the main entrance or doorway of the destination and in general proximity to bike and pedestrian paths. Separate curb cuts for bicycle access to/from the street to a site are discouraged but may be considered where appropriate. Bicycle parking facilities shall not interfere with pedestrian or vehicular circulation.
- D. **Parking Rack/Device Requirements.** Bicycle racks or parking devices shall:
 - 1. Support a bicycle in at least two places, preventing it from falling over.
 - 2. Be securely anchored to the ground.
 - 3. Resist cutting, rusting, bending, or deformation.
 - 4. Be designed to prevent scratching of bicycles.
- E. **Weather Protection.** Long-term bicycle parking areas shall be protected from weather and covered with a canopy or roof, either freestanding or attached to an existing building.
- F. **Damage Prevention.** Bike parking facilities within automobile parking areas shall be separated by a physical barrier to protect bicycles from damage by cars, such as curbs, wheel stops, bollards or other similar features.
- G. **Locking Device.** Bicycle racks or parking devices must accommodate common secure personal locking devices, including U-locks.
- H. **Lighting.** Bicycle parking expected to be used at night must be illuminated.
- I. **Signage.** Where short-term bicycle parking areas are not clearly visible to approaching bicyclists, signs of at least 12" square shall direct them to the facility. Signs shall give the name, phone number and location of the person in charge of the facility, where applicable. Where long-term bicycle parking is provided by restricted access, signs shall state that the enclosure must be kept locked at all times.
- J. **Minimize Obstructions.**
 - 1. A minimum of 3' must be provided between each side of a bicycle rack and a vertical obstruction, such as a wall.

2. A bike rack must be a minimum of 32" from either a vehicle overhang or a curb where the door of a parked vehicle would open.
 3. When designing a bicycle parking facility, consider providing access from multiple sides to ensure all parking spaces can be used.
- K. **Maneuvering.** A minimum 5' aisle or space shall be provided for bicycles to enter and leave the facility. In an enclosed space where bicycles are parked perpendicular to a wall, the aisle shall have a width of at least 7' to the front or rear of a bicycle parked in the facility. Maneuvering space should allow for simultaneous users, provide for entry and exit of the facility and accommodate rack operations and lifting of bicycles where necessary.
- L. **Stairwells.** Access to bicycle parking that requires the user to use stairways is discouraged. If the access must require use of stairs, such as access to the site itself or to a unit, grooves along the side of the stairs or a bike rail are recommended.
- M. **Non-standard Bicycles.** There is often a relationship between a land-use and an expected bicycle type (i.e., cargo bikes or trailers at grocery stores or child trailers at schools). Nonstandard bicycle types such as recumbent bikes, folding bikes, cargo bikes, as well as traditional bikes equipped with child carriers, trailers, and/or baskets, which are common on utility bicycles, should be considered in bike parking design.
- N. **Group Bicycle Parking.** Consider providing group short-term bicycle parking in active commercial or recreational areas where individual rack element is inadequate to meet short-term bicycle parking demands. Depending on use, demand and location, group bicycle parking may be located on private property or within the sidewalk corridor or in the street with approval from the Transportation Planning & Parking Manager.
- O. **Vertical Racks.** Vertical racks are bike racks that require a bicycle to be lifted and hung on a wall. A maximum of 30% of required bicycle parking may be provided in vertical racks.
- P. **Stacked Racks.** Where stacked parking is proposed, lifting assistance mechanisms shall be provided to accommodate more users.

FIGURE 8: SHORT-TERM BICYCLE RACK LAYOUT

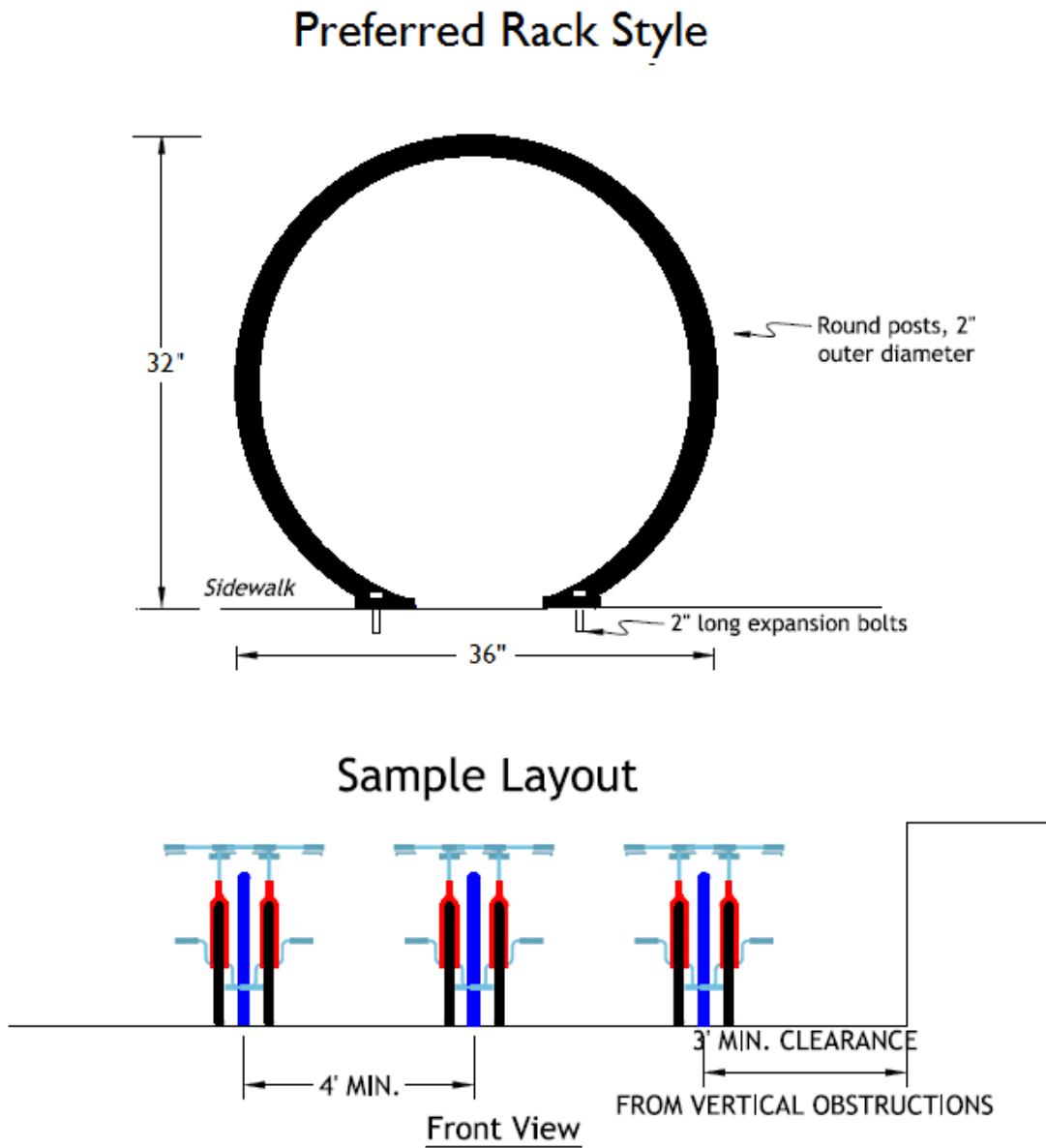
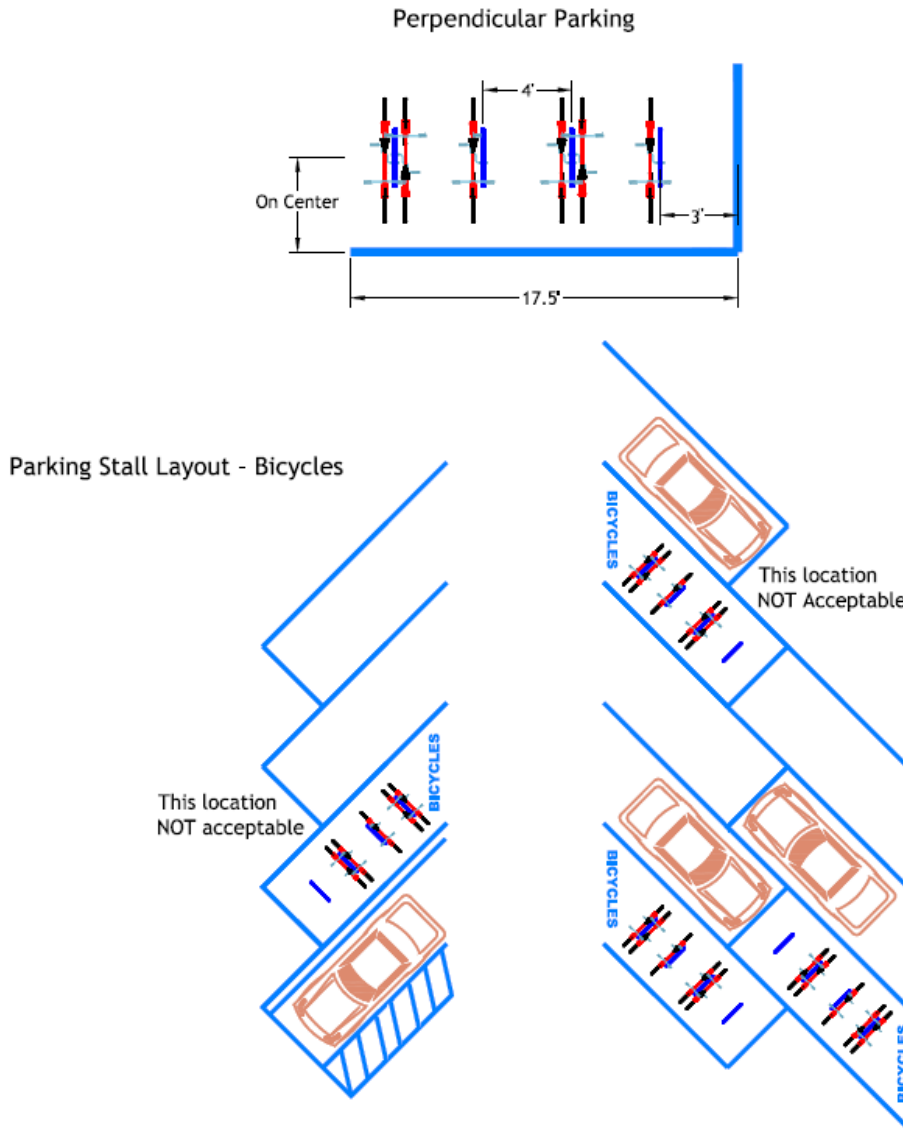

FIGURE 9: SHORT-TERM BICYCLE PARKING LOT LAYOUT



Bicycle parking should be restricted to end spaces in parking lots, preferably without edge curbing being present. Priority to Disabled Parking first, followed by bicycles.

Physical separation, such as wheel stops or bollards, are required if there is a vehicle parking space opposite the bicycle parking area.

This type of bicycle parking is not typically recommended, but may be a solution when looking to convert vehicle parking spaces. If considering, please contact the Transportation Division.